



W o r l d L e a d e r i n D e n t a l A t t a c h m e n t s

PRICE LIST

for Dentist and Dental Laboratory



19th Edition

w w w . r h e i n 8 3 3 . c o m



CASTABLE



Ref. 092ECQ

OT EQUATOR CASTABLE KIT

KIT CONTAINS:

- 2 SINGLE MALES
- 2 STAINLESS STEEL HOUSINGS
- 4 RETENTIVE CAPS
(2 SOFT, 2 STANDARD)

€ 50.00

IMPLANTS



Ref. 130

OT EQUATOR FOR IMPLANTS KIT

KIT CONTAINS:

- 1 OT EQUATOR TITANIUM + TiN ABUTMENT
- 1 STAINLESS STEEL HOUSING
- 1 PROTECTIVE DISK
- 4 RETENTIVE CAPS
(1 EXTRA-SOFT, 1 SOFT, 1 STANDARD, 1 STRONG)

€ 115.00



Ref. 131

OT EQUATOR AND SMARTBOX FOR IMPLANTS KIT

KIT CONTAINS:

- 1 OT EQUATOR TITANIUM + TiN ABUTMENT
- 1 ANODIZED SMART BOX HOUSING WITH BLACK POSITIONING CAP
- 1 PROTECTIVE DISK
- 4 RETENTIVE CAPS
(1 EXTRA-SOFT, 1 SOFT, 1 STANDARD, 1 STRONG)

€ 125.00



Ref. 030

- 1 OT EQUATOR TITANIUM + TiN ABUTMENT

€ 80.00

THE OT EQUATOR ATTACHMENTS ARE AVAILABLE FOR THE MAJOR IMPLANT BRANDS. UPON REQUEST WE CAN CUSTOMIZE THEM FOR ANY KIND OF IMPLANTS. WHEN ORDERING INDICATE: IMPLANT, DIAMETER AND CUFF HEIGHT. CUFF AVAILABLE TO 7mm.

BARS



Ref. 160EQB

OT EQUATOR THREADED SLEEVE SYSTEM KIT FOR BONDING

KIT CONTAINS:

- 2 EQUATOR THREADED for titanium sleeve (1.6 mm THREAD)
- 2 THREADED SLEEVES (1.6 mm THREAD)
- 2 STAINLESS STEEL HOUSINGS
- 2 EQUATOR SPACERS
- 8 RETENTIVE CAPS
(2 EXTRA-SOFT, 2 SOFT, 2 STANDARD, 2 PROCESSING)

€ 125.00

ELASTIC SEEGER PASSIVE BAR CONNECTIONS SYSTEM



Ref. 158ESA

ELASTIC SEEGER KIT

KIT CONTAINS:

- 1 CASTABLE CYLINDER FOR SEEGER
- 1 SELF-EXTRACTING SEEGER
- 1 TITANIUM SCREW FOR SELF-EXTRACTING SEEGER

€ 27.00

CAPS ASSORTMENT KIT



Ref. 192ECE

CAPS ASSORTMENT KIT

KIT CONTAINS:

- 1 STAINLESS STEEL HOUSING
- 1 PROCESSING CAP
- 1 PROTECTIVE DISK
- 4 RETENTIVE CAPS (1 EXTRA-SOFT, 1 SOFT, 1 STANDARD, 1 STRONG)

€ 38.00

SMART BOX KIT



Ref. 335SBC



















SMART BOX KIT

KIT CONTAINS:





- 1 SMART BOX HOUSING WITH BLACK POSITIONING CAP
- 1 PINK PROTECTIVE DISK
- 4 RETENTIVE CAPS (1 EXTRA-SOFT, 1 SOFT, 1 STANDARD, 1 STRONG)

€ 45.00









SPARE PARTS

	Ref. 151SS	• 2 CASTABLE MALES	€ 20.00
	Ref. 140CEV	• 4 RETENTIVE CAPS - VIOLET "STRONG" 2700g	€ 28.00
	Ref. 140CET	• 4 RETENTIVE CAPS - CLEAR "STANDARD" 1800g	€ 28.00
	Ref. 140CER	• 4 RETENTIVE CAPS - PINK "SOFT" 1200g	€ 28.00
	Ref. 140CEG	• 4 RETENTIVE CAPS - YELLOW "EXTRA-SOFT" 600g	€ 28.00
	Ref. 140CEN	• 4 PROCESSING CAPS - BLACK (FOR LABORATORY USE ONLY)	€ 14.00
	Ref. 141CAE	• 2 STAINLESS STEEL HOUSINGS	€ 20.00
	Ref. 141CTE	• 2 TITANIUM HOUSINGS	€ 28.00
	Ref. 330SBE	• 1 SMART BOX HOUSING WITH BLACK POSITIONING CAP	€ 25.00
	Ref. 335CSB	• 4 BLACK SMARTBOX POSITIONING CAPS	€ 16.00
	Ref. 039SFE2	• 1 EQUATOR THREADED 2.0mm (DIRECT INTO 2mm THREAD)	€ 25.00
	Ref. 339SFE	• 1 EQUATOR THREADED 1.6mm (FOR TITANIUM SLEEVE)	€ 25.00
	Ref. 239GSF	• 1 TITANIUM SLEEVE (1.6mm THREAD)	€ 24.00
	Ref. 339SSE	• 1 OT EQUATOR SPACER	€ 10.00
	Ref. 158VAE	• 1 TITANIUM SCREW FOR SELF-EXTRACTING SEEGER	€ 15.00
	Ref. 158SAE	• 1 SELF-EXTRACTING WHITE SEEGER (FOR BAR LOCKING)	€ 15.00
	Ref. 158CCE	• 1 CASTABLE CYLINDER height 2,5mm (FOR SEEGER)	€ 15.00
	Ref. 158CCA	• 1 HIGH CASTABLE CYLINDER height 3,5mm (FOR SEEGER)	€ 15.00

ACCESSORIES

	Ref. 144TTE	• 1 OT EQUATOR TITANIUM TRANSFER + TITANIUM SCREW	€ 44.00
	Ref. 144MTE	• 2 IMPRESSION COPINGS (FOR INDIVIDUAL TRAY)	€ 36.00
	Ref. 044CAIN	• 2 IMPRESSION COPINGS NORMAL SIZE - OT EQUATOR (WITH INTERCHANGEABLE CAP FOR PICK UP IMPRESSION)	€ 25.00
	Ref. 144AE	• 2 LABORATORY ANALOGS	€ 38.00

TOOLS

	Ref. 74AC01	• 1 PARALLELOMETER KEY "NORMAL SIZE"	€ 22.00
	Ref. 774CHE	• 1 OT EQUATOR SQUARE SCREW DRIVER + HOLDER (SQUARE 1.25mm)	€ 42.00
	Ref. 774HC	• 1 OT EQUATOR INTERCHANGEABLE HOLDER	€ 8.00
	Ref. 760CE	• 1 SQUARE DRIVER CONNECTOR for torque CONTROLLER CONTRA ANGLE (SQUARE 1.25mm)	€ 39.00
	Ref. 485IC	• 1 MULTIUSE CAPS INSERTER/EXTRACTOR TOOL	€ 39.00
	Ref. 185SIS	• 1 METAL INSERTION TOOL FOR SEEGER USE TOGETHER WITH 491EC	€ 12.00
	Ref. 491EC	• 1 MULTIUSE EXTRACTOR TOOL FOR CAPS (WITH HOLE STEM HOLDER)	€ 29.00
	Ref. 760CRD	• 1 RATCHET TORQUE CONTROL DEVICE (FOR OT EQUATOR, SPHERO BLOCK AND FLEX 15/35NCM STRENGHT - MAX 50NCM TORQUE, SUGGESTED 25NCM)	€ 310.00

OT UNILATERAL

EXTRA CORONAL ATTACHMENTS WITH COMBINED FUNCTION



Ref. 098UNL

OT UNILATERAL + CONNECTOR

KIT CONTAINS:

- 1 UNILATERAL CASTABLE ATTACHMENT
- 1 UNI-BOX CASTABLE
- 1 PLASTIC POSITIONER MICRO SIZE
- 1 PINK CAP MICRO SIZE
- 1 STRATEGY YELLOW CAP (for duplication technique)
- 1 BLACK CAP MICRO SIZE (for laboratory use only)
- 1 STRATEGY BLACK CAP (for laboratory use only)
- 1 CONNECTOR

€ 35.00



Ref. 156BCU

- 1 UNILATERAL CASTABLE ATTACHMENT

€ 12.00



Ref. 156CCU

- 1 UNI-BOX CASTABLE

€ 12.00

OT CAP TECNO



NORMAL

Ref. 093CTN

OT CAP TECNO NORMAL/MICRO

KIT CONTAINS:

- 2 PRE-ANGULATED CASTABLE EXTENSIONS
- 2 TITANIUM SINGLE THREADED SPHERES
- 2 TITANIUM BOND-IN THREADED SLEEVES
- 2 TRANSPARENT CAPS NORMAL/MICRO
- 2 PINK CAPS NORMAL/MICRO
- 2 YELLOW CAPS NORMAL/MICRO

€ 92.00



MICRO

Ref. 093CTM



Ref. 193BCA

- 2 PRE-ANGULATED CASTABLE EXTENSIONS

€ 10.00

SINGLE THREADED SPHERES

WITH THREADED SLEEVE TO BE BONDED NORMAL - MICRO



Ref. 139KSFN

KIT SINGLE THREADED SPHERE NORMAL SIZE + TiN WITH SLEEVE TO BE BONDED

KIT CONTAINS

- 2 TITANIUM NORMAL SINGLE THREADED SPHERE
(*HEX mm. 1.3 THREAD mm. 1.6*)
- 2 TITANIUM BOND-IN THREADED SLEEVE
- 2 S/STEEL SPACER for the THREADED SLEEVE (Normal sphere)

€ 88.00



Ref. 139KSFM

KIT SINGLE THREADED SPHERE MICRO SIZE + TiN WITH SLEEVE TO BE BONDED

KIT CONTAINS

- 2 TITANIUM MICRO SINGLE THREADED SPHERE
(*HEX mm. 0.9 THREAD mm. 1.6*)
- 2 TITANIUM BOND-IN THREADED SLEEVE
- 2 S/STEEL SPACER for the THREADED SLEEVE (Micro sphere)

€ 88.00

SPARE PARTS



Ref. 239SFN

- 1 SINGLE THREADED SPHERE NORMAL SIZE + TiN
FOR THREADED SLEEVE HEX mm. 1.3 THREAD mm. 1.6

€ 20.00



Ref. 239SFM

- 1 SINGLE THREADED SPHERE MICRO SIZE + TiN
FOR THREADED SLEEVE HEX mm. 0.9 THREAD mm. 1.6

€ 20.00



Ref. 239GSF

- 1 TITANIUM BOND-IN THREADED SLEEVE
FOR NORMAL AND MICRO - mm. 1.6

€ 24.00



Ref. 239SSN

- 1 **STAINLESS STEEL SPACER for THREADED SLEEVE (Normal sphere)**

€ 10.00

Ref. 239SSM

- 1 **STAINLESS STEEL SPACER for THREADED SLEEVE (Micro sphere)**

€ 10.00

SINGLE THREADED SPHERES

FOR CAD/CAM OR SELF TAPPING 2.0mm THREAD - NORMAL AND MICRO SIZE



Ref. 039SFN2

- 1 **SINGLE THREADED SPHERE NORMAL SIZE + TiN**
HEX 1.3mm, THREAD 2.0mm

€ 20.00

Ref. 039FM2

- 1 **SINGLE THREADED SPHERE MICRO SIZE + TiN**
HEX 0.9mm, THREAD 2.0mm

€ 20.00



Ref. 760CBR

- 1 **HEX DRIVER FOR THREADED SPHERE NORMAL**
HEX 1.3mm

€ 39.00



Ref. 772CSF

- 1 **HEX DRIVER FOR THREADED SPHERE MICRO**
HEX 0.9mm

€ 39.00

OT CAP IMPRESSION COPINGS



Ref. 044CAIN

- 2 **IMPRESSION COPINGS NORMAL SIZE**
Ø2,5mm WITH INTERCHANGEABLE CAP

€ 25.00

Ref. 044CAI22

- 2 **IMPRESSION COPINGS**
Ø2,25mm SPHERES WITH INTERCHANGEABLE CAP

€ 25.00

Ref. 044CAIM

- 2 **IMPRESSION COPINGS MICRO SIZE**
Ø1,8mm WITH INTERCHANGEABLE CAP

€ 25.00

ATTACHMENTS OT CAP & OT BOX - OT STRATEGY - OT BAR OT VERTICAL - OT TECNO - TITANIUM SINGLE SPHERE

MASTER STARTER KIT FOR LABORATORY



Ref. 005SKLUS

KIT CONTAINS:

OT CAP - OT BOX SYSTEM:

- 16 castable assorted pivots (normal and micro size)
- 4 castable spheres (normal and micro size)
- 2 titanium single spheres (normal and micro size) + sphere holder + 2 sliding base
- 4 castable OT CAP bars (normal and micro size)
- 2 complete castable OT CAP TECNO bars (normal and micro size)
- 4 castable OT BOX CLASSIC bars (upper + lower part) normal and micro size
- 2 castable OT BOX SPECIAL bars (normal and micro size)
- 6 castable OT BOX connectors
- 4 castable OT BOX MONO housings (normal and micro size)
- 4 plastic positioner rings (normal and micro size)
- 16 OT CAP retentive caps (normal and micro size)
Clear - standard retention - PINK soft retention - YELLOW extra soft retention
GREEN very elastic retention

- 4 TITAN CAP titanium caps (normal and micro size)
- 4 BLACK CAPS - only for lab use - (normal and micro size)
- 8 S/STEEL housings
- 4 ANALOGUES for plaster models (normal and micro size)
- 4 protective disks
- 4 aluminium spacers (normal and micro size)

OT STRATEGY:

- 4 castable spheres (2 standard and 2 high)
- 2 castable STEADY
- 6 retentive caps: 2 clear - 2 pink - 2 yellow for housing
- 2 black caps for housing only for lab use
- 2 s/steel housings
- 2 plastic positioner rings
- 6 retentive caps for duplication technique:
Clear - standard retention - PINK soft retention - YELLOW extra soft retention
- 2 black caps for duplication technique only for lab use
- 2 ANALOGUES for plaster models

OT BAR MULTIUSE:

- 2 castable bar
- 1 gingival connector
- 2 positioner clip A
- 2 positioner clip B
- 4 castable housings
- 4 clips - 2 PINK - soft retention - 2 YELLOW medium retention

OT VERTICAL:

- 2 castable male
- 2 castable STEADY
- 4 clips - 2 WHITE - standard retention - 2 GREEN soft retention
- 2 castable parallelometer keys
- 2 ceramic bars

TOOLS:

- 1 Pincers
- 2 Reamer tools for caps (normal and micro size)
- 1 Reamer tools for OT STRATEGY caps
- 2 Parallelometer keys for OT CAP (normal and micro size)
- 1 Parallelometer key for OT STRATEGY size
- 2 Parallelometer keys for OT CAP TECNO (normal and micro size)
- 1 Parallelometer key for OT BAR MULTIUSE
- 1 Blue Plastic "multiuse" insertion tool
(for steel tool and for inserting the caps in the mouth)
- 1 OT CAP insertion tool
- 1 OT STRATEGY insertion tool
- 1 OT BAR clips insertion tool
- 1 OT VERTICAL clips insertion tool

€ 400.00

ATTACHMENTS OT CAP & OT BOX - OT STRATEGY - OT BAR

OT VERTICAL - OT UNILATERAL - OT EQUATOR

BASIC LABORATORY KIT



Ref. 005SKLBUS

KIT CONTAINS:

OT CAP - OT BOX SYSTEM:

- 16 castable assorted pivots (normal and micro size)
- 8 castable spheres normal/micro
- 2 castable OT CAP bars (normal and micro size)
- 2 castable OT BOX CLASSIC bars (upper + lower part) normal and micro size
- 2 castable OT BOX SPECIAL bars (normal and micro size)
- 6 castable OT BOX connectors
- 4 castable OT BOX MONO housings (normal and micro size)
- 8 plastic positioner rings (normal and micro size)
- 13 OT CAP assorted retentive caps (normal and micro size)
PINK soft retention - YELLOW extra soft retention
- 13 BLACK CAPS- only for lab use - (normal and micro size)
- 4 S/STEEL housings (normal and micro size)

OT STRATEGY:

- 4 castable spheres (2 standard and 2 high)
- 2 castable STEADY
- 2 pink retentive caps
- 2 s/steel housings
- 2 plastic positioner rings
- 3 retentive caps for duplication technique:
PINK soft retention - YELLOW extra soft retention
- 4 black caps for duplication technique only for lab use

OT EQUATOR:

- 2 single males
- 2 stainless steel housings
- 4 retentive caps (2 soft, 2 standard)
- 2 processing black caps

OT UNILATERAL:

- 1 unilateral castable attachment
- 1 uni-box castable
- 1 plastic positioner micro size
- 2 ot cap micro size: 1 pink - 1 black processing cap
- 2 ot strategy (for duplication technique): 1 yellow - 1 black processing cap
- 1 connector

OT BAR MULTIUSE:

- 1 castable bar
- 1 gingival connector
- 4 positioner clip (A - B)
- 2 castable housings
- 4 clips - 2 PINK - soft retention - 2 YELLOW medium retention

OT VERTICAL:

- 2 castable male
- 2 castable STEADY
- 4 clips - 2 WHITE- standard retention - 2 GREEN soft retention
- 2 castable parallelometer keys
- 2 ceramic bars

TOOLS:

- 1 Tweezers
- 1 Parallelometer keys for OT CAP normal
- 1 Parallelometer keys for OT CAP micro
- 1 Parallelometer key for OT STRATEGY
- 1 Parallelometer key for OT BAR MULTIUSE
- 1 Blue Plastic "multiuse" insertion tool
(for steel tool and for inserting the caps in the mouth)
- 1 OT CAP insertion tool
- 1 OT STRATEGY insertion tool
- 1 OT BAR clips insertion tool
- 1 OT VERTICAL clips insertion tool

€ 150.00

OT CAP SYSTEM ATTACHMENTS



Ref. 038STF
NORMAL SIZE

TITANIUM FLEX SINGLE SPHERE NORMAL SIZE + TiN FOR LASER SOLDERING - FOR BONDING

KIT CONTAINS:

- 2 SINGLE TITANIUM FLEX SPHERES
- 2 PINK CAPS - SOFT RETENTION
- 1 SPHERE HOLDER
- 2 CASTABLE SLIDING BASES

€ 75.00

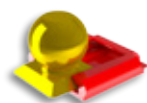

Ref. 038STN
NORMAL SIZE

TITANIUM SINGLE SPHERE NORMAL SIZE + TiN FOR LASER SOLDERING - FOR BONDING

KIT CONTAINS:

- 2 SINGLE TITANIUM SPHERES
- 2 PINK CAPS - SOFT RETENTION
- 1 SPHERE HOLDER
- 2 CASTABLE SLIDING BASES

€ 50.00



Ref. 038STM
MICRO SIZE

TITANIUM SINGLE SPHERE MICRO SIZE + TiN FOR LASER SOLDERING - FOR BONDING

KIT CONTAINS:

- 2 SINGLE TITANIUM SPHERES
- 2 PINK CAPS - SOFT RETENTION
- 1 SPHERE HOLDER
- 2 CASTABLE SLIDING BASES

€ 50.00



Ref. 092CAN

**NORMAL SIZE OT CAP
KIT CONTAINS**

- 4 CASTABLE SINGLE SPHERES
- 4 PINK RETENTIVE CAPS
- 4 STAINLESS STEEL HOUSINGS
- 4 PLASTIC POSITIONERS

€ 49.00



Ref. 092CAM

**MICRO SIZE OT CAP
KIT CONTAINS**

- 4 CASTABLE SINGLE SPHERES
- 4 PINK RETENTIVE CAPS
- 4 STAINLESS STEEL HOUSINGS
- 4 PLASTIC POSITIONERS

€ 49.00



Ref. 196BCN

**"ECONOMIC" OT CAP NORMAL SIZE
KIT CONTAINS**

- 1 CASTABLE PRESECTIONED BAR
- 1 CASTABLE PRESECTIONED BEVELED BAR
- 4 CLEAR RETENTIVE CAPS (Standard retention)

€ 39.00



Ref 197BCM

**"ECONOMIC" OT CAP MICRO SIZE
KIT CONTAINS**

- 1 CASTABLE PRESECTIONED BAR
- 1 CASTABLE PRESECTIONED BEVELED BAR
- 4 CLEAR RETENTIVE CAPS (Standard retention)

€ 39.00



Ref. 099BSN

**OT CAP & Mono OT BOX FOR FRAME NORMAL SIZE
KIT CONTAINS**

- 2 CASTABLE PRESECTIONED BARS (1 straight + 1 beveled)
- 4 CLEAR RETENTIVE CAPS
- 4 CASTABLE MONO OT BOX
- 4 PLASTIC POSITIONERS

€ 64.00



Ref. 099BSM

**OT CAP & Mono OT BOX FOR FRAME MICRO SIZE
KIT CONTAINS**

- 2 CASTABLE PRESECTIONED BARS (1 straight + 1 beveled)
- 4 CLEAR RETENTIVE CAPS
- 4 CASTABLE MONO OT BOX
- 4 PLASTIC POSITIONERS

€ 64.00



Ref. 058BSN

**OT BOX SPECIAL NORMAL SIZE + CONNECTORS
KIT CONTAINS**

- 2 OT BOX SPECIAL BARS
- 4 PLASTIC POSITIONERS
- 4 CONNECTORS

€ 37.00



Ref. 058BSM

**OT BOX SPECIAL MICRO SIZE + CONNECTORS
KIT CONTAINS**

- 2 OT BOX SPECIAL BARS
- 4 PLASTIC POSITIONERS
- 4 CONNECTORS

€ 37.00



Ref. 153BCN

**OT BOX CLASSIC NORMAL SIZE + CONNECTORS
KIT CONTAINS:**

- 2 UPPER BARS
- 2 LOWER BARS
- 4 PLASTIC POSITIONERS
- 4 CONNECTORS

€ 34.00



Ref. 153BCM

**OT BOX CLASSIC MICRO SIZE + CONNECTORS
KIT CONTAINS:**

- 2 UPPER BARS
- 2 LOWER BARS
- 4 PLASTIC POSITIONERS
- 4 CONNECTORS

€ 34.00

OT BOX LARGE

OVERSIZED CASTABLE HOUSING FOR CHAIRSIDE POSITIONING OF CAPS



Ref. 253BLN

OT BOX LARGE NORMAL & CONNECTORS

KIT CONTAINS

- 2 OT BOX LARGE BARS
- 4 PLASTIC POSITIONERS
- 4 CONNECTORS

€ 34.00



Ref. 253BLM

OT BOX LARGE MICRO & CONNECTORS

KIT CONTAINS:

- 2 OT BOX LARGE BARS
- 4 PLASTIC POSITIONERS
- 4 CONNECTORS

€ 34.00

OT STRATEGY ATTACHMENTS



Ref. 098SSS

OT STRATEGY

CAPS FOR DUPLICATION TECHNIQUE

KIT CONTAINS

- 4 CASTABLE STRATEGY MALES (2 STANDARD - 2 HIGH)
- 2 CASTABLE STEADY
- 4 RETENTIVE CAPS FOR DUPLICATION TECHNIQUE

€ 49.00



Ref. 098CAL

OT STRATEGY

CAPS FOR STAINLESS STEEL HOUSING TECHNIQUE

KIT CONTAINS

- 4 CASTABLE STRATEGY MALES (2 STANDARD - 2 HIGH)
- 2 CASTABLE STEADY
- 4 STAINLESS STEEL HOUSINGS
- 2 PLASTIC POSITIONERS
- 4 RETENTIVE CAPS FOR HOUSING TECHNIQUE

€ 59.00

OT BAR MULTIUSE ATTACHMENTS



Ref. 021OBM

OT BAR MULTIUSE & CONNECTORS

KIT CONTAINS

- 2 CASTABLE BARS
- 4 POSITIONER CLIP A
- 4 POSITIONER CLIP B
- 4 CASTABLE BOXES
- 4 RETENTIVE PINK CLIPS
- 4 RETENTIVE YELLOW CLIPS
- 4 RETENTIVE RED CLIPS
- 2 CONNECTORS
- 1 GINGIVAL CONNECTOR

€ 92.00

OT VERTICAL ATTACHMENTS



Ref. 071OBV

OT VERTICAL

KIT CONTAINS

- 4 CASTABLE MALES
- 2 CASTABLE STEADY
- 4 RETENTIVE WHITE CLIPS
- 2 RETENTIVE GREEN CLIPS
- 4 CASTABLE PARALLELOMETER KEYS + PIN

€ 50.00

OVERDENTURE ATTACHMENTS



Ref. 011SPL

S.P.L. PIVOTS - COPING COVER PROMOTIONAL KIT FOR CLINIC

KIT CONTAINS

- 24 CASTABLE ASSORTED PIVOTS MICRO SIZE
- 40 CASTABLE ASSORTED PIVOTS NORMAL SIZE
- 12 TITANIUM MICRO PIVOTS
- 12 TITANIUM NORMAL PIVOTS
- 16 NORMAL CAPS (Clear - standard retention - PINK soft retention)
- 16 MICRO CAPS (Clear - standard retention - PINK soft retention)
- 20 PROTECTIVE DISKS
- 2 REGULATING TOOLS (1 normal and 1 micro size)
- 1 BLUE PLASTIC "MULTIUSE" INSERTION TOOL (FOR THE INSERTION OF THE CAPS INSIDE THE METAL HOUSINGS)
- 1 OT CAP insertion tool
- 4 NORMAL STAINLESS STEEL HOUSING
- 4 MICRO STAINLESS STEEL HOUSING
- 12 DIRECTIONAL RINGS (grey 0° - green 7° - red 14°)
- 1 TWEEZER

€ 310.00



Lenghts available:
10 - 9 - 7mm

Ref. 333PEK7

Ref. 333PEK9

Ref. 333PEK10

OT EQUATOR TITANIUM TiN COATED PIVOTS KIT

Low profile head pivots

KIT CONTAINS

- 2 TITANIUM OT EQUATOR PIVOTS h7,9 or 10mm (of the same length chosen)
- 2 OT EQUATOR ANODIZED TITANIUM HOUSINGS
- 2 YELLOW EXTRA SOFT CAPS
- 2 PINK SOFT CAPS
- 2 CLEAR STANDARD CAPS
- 2 TRANSPARENT PROTECTIVE DISKS

€ 85.00



Lenghts available:
10 - 9 - 7mm

Ref. 336PTE7

Ref. 336PTE9

Ref. 336PTE10

OT EQUATOR TITANIUM TiN COATED PIVOTS

Low profile head pivots

KIT CONTAINS

- 1 TITANIUM OT EQUATOR PIVOT h7,9 or 10mm (of the length chosen)

€ 38.00

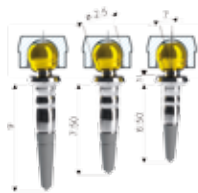

Ref. 033PSF

PIVOT FLEX TiN COATED

TITANIUM PIVOT WITH SWIVEL SPHERE - Normal size
Adapted for COPING COVER

KIT CONTAINS

- 1 TITANIUM PIVOT WITH SWIVEL SPHERE
- 1 STAINLESS STEEL HOUSING
- 2 PINK CAPS Normal Size - Soft retention
- 1 PROTECTIVE DISK
- 3 DIRECTIONAL RINGS

€ 48.00

Lenghts available: 7,9 or 10mm
Normal sphere ø2,5mm
Micro sphere ø1,8mm



Ref. 036PTN7

Ref. 036PTN9

Ref. 036PTN10

TITANIUM PIVOTS KIT NORMAL SIZE

Adapted for COPING COVER

KIT CONTAINS

- 5 TITANIUM PIVOTS (Adapted for COPING COVER)

€ 39.00

Ref. 036PTM7

Ref. 036PTM9

Ref. 036PTM10

TITANIUM PIVOTS KIT MICRO SIZE

Adapted for COPING COVER

KIT CONTAINS

- 5 TITANIUM PIVOTS (Adapted for COPING COVER)

€ 39.00



STANDARD LENGTH

Ref. 034PRK

OVERDENTURE POSTS

FOR ROOTS, AVAILABLE IN ONE STANDARD SIZE

KIT CONTAINS

- 2 Root posts in Titanium + TiN
- 2 Retentive male attachment Titanium + nylon
- 2 Plastic manual tools
- 2 Stainless steel housings
- 2 Pink protective disks

€ 120.00

Lenghts available:
14 - 12 - 10 - 9 - 7mm



Ref. 010PSP

CASTABLE PIVOTS

FOR CANAL IMPRESSIONS

KIT CONTAINS

- 20 CASTABLE PIVOTS NORMAL SIZE

€ 24.00

Lenghts available:
10 - 9 - 7mm



Ref. 012PSM

CASTABLE PIVOTS

FOR CANAL IMPRESSIONS

KIT CONTAINS

- 20 CASTABLE PIVOTS MICRO SIZE

€ 26.00

Ref. A01MOG

MOOSER BUR

FOR PIVOTS OF 7 - 9 - 10mm.

€ 15.00

Ref. A03MOB

MOOSER BUR

FOR PIVOTS OF 12 - 14mm.

€ 15.00

Ref. 121FD

OT REVERSE 3 DIAMOND SHAPED BUR FOR ROOTS

€ 25.00

SPHERO FLEX WITH TiN COATED



Ref. 109

KIT CONTAINS

- 1 TITANIUM ABUTMENT WITH SWIVEL SPHERE (SPHERE Ø 2.5 mm.)
- 3 CAPS (Yellow - Pink - Clear)
- 1 STAINLESS STEEL HOUSING
- 1 PROTECTIVE DISK
- 3 DIRECTIONAL RINGS

€ 103.00

SPHERO BLOCK NORMO WITH TiN COATED



Ref. 002

KIT CONTAINS

- 1 TITANIUM ABUTMENT (SPHERE Ø mm. 2.5)
- 3 CAPS (Yellow - Pink - Clear)
- 1 STAINLESS STEEL HOUSING
- 1 PROTECTIVE DISK
- 3 DIRECTIONAL RINGS

€ 85.00

SPHERO BLOCK MICRO WITH TiN COATED



Ref. 003

KIT CONTAINS:

- 1 TITANIUM ABUTMENT (SPHERE Ø mm. 1.8)
- 3 CAPS (Yellow - Pink - Clear)
- 1 STAINLESS STEEL HOUSING
- 1 PROTECTIVE DISK
- 3 DIRECTIONAL RINGS

€ 85.00

THE SPHERO FLEX, SPHERO BLOCK ATTACHMENTS ARE AVAILABLE FOR THE MAJOR IMPLANT BRANDS. UPON REQUEST WE CAN CUSTOMIZE THEM FOR ANY KIND OF IMPLANTS. WHEN ORDERING, PLEASE ALWAYS INDICATE: IMPLANT BRAND, IMPLANT DIAMETER AND CUFF HEIGHT. FOR SPHERO FLEX ABUTMENT CUFF AVAILABLE FROM 0,5 TO 7mm.



AUXILIARY TOOLS SPHERO FLEX - BLOCK



Ref. 771CEF

KEY FOR SPHERO FLEX AND SPHERO BLOCK (Normal - Micro size)
HEX mm. 2.3

€ 48.00



Ref. 760CBM

HEX SCREWDRIVER FOR TORQUE CONTROLLER CONTRA ANGLE

€ 39.00



Ref. 760CRD

RATCHET TORQUE CONTROL DEVICE
For Sphero block - flex and Ot Equator
15/35Ncm Strength - Max 50Ncm torque, suggested 25Ncm.

€ 310.00

ANTI-UNSCREWING SYSTEM WITH AN ELASTIC DOWEL APPLICABLE TO

SPHERO FLEX-BLOCK - OT REVERSE AND DIFFERENT SCREWS. THE ELASTIC DOWEL IS APPLICABLE ONLY UPON REQUEST TO ALL SCREWS WITH A NOT INFERIOR M. 1.8 to screws - Sphero Flex - Sphero Block - OT Reverse attachments, etc.

Ref. TE

Extra charge for the dowel application



ELASTIC DOWEL

€ 20.00

AUXILIARY TOOLS SPHERO FLEX - BLOCK



Ref. 100AD

DIRECTIONAL RINGS FOR SPHERO FLEX AND BLOCK

KIT CONTAINS

- 3 COLOURED RINGS WITH INCLINATION OF 0° - 7° - 14°

€ 10.00



Ref. 044ABN

SPHERO FLEX - BLOCK NORMO ANALOG KIT

KIT CONTAINS

- 1 SPHERO BLOCK-FLEX NORMO ANALOG
- 3 DIRECTIONAL RINGS (0° - 7° - 14°)
- 1 BLACK NORMO CAP FOR LABORATORY USE

€ 18.00



Ref. 044ABM

SPHERO BLOCK MICRO ANALOG KIT

KIT CONTAINS:

- 1 SPHERO BLOCK-MICRO ANALOG
- 3 DIRECTIONAL RINGS (0° - 7° - 14°)
- 1 BLACK MICRO CAP FOR LABORATORY USE

€ 18.00

CUFF HEIGHT MEASURER

THIS TOOL IS USED TO DETERMINE THE CUFF HEIGHT OF IMPLANTS WITH INTERNAL OR EXTERNAL HEXAGON



Ref. 008MBG

CUFF HEIGHT MEASURER

KIT CONTAINS:

- 1 CUFF HEIGHT SLIDER GAUGE
- 1 CUFF HEIGHT FIXED ROD GAUGE
- 1 SILICON RING DISPENSER
- 20 SILICON RINGS



€ 80.00

OT LOCK

LOCKING PIN TITANIUM AND CASTABLE



Ref. 880CLT

OT LOCK KIT TITANIUM

KIT CONTAINS

- 1 LOCKING PIN SET
- 1 HOUSING SHAPER
- 1 CERAMIC PIN

€ 70.00



Ref. 880CLR

OT LOCK KIT TITANIUM ADJUSTABLE

KIT CONTAINS

- 1 LOCKING PIN SET
- 1 HOUSING SHAPER
- 1 CERAMIC PIN
- 9 CASTABLE SPACER RINGS

€ 70.00

OT LOCK ACCESSORIES



Ref. 882CG

- 1 CONICAL GUIDE

€ 10.00



Ref. 882CAS

- 1 UNLOCKING TOOL

€ 15.00

SPARE PARTS OT CAP SYSTEM NORMAL Ø2.5mm



Ref. 055SCN	• 4 CASTABLE SINGLE SPHERES NORMAL SIZE	€ 19.00
Ref. 151BAN	• 2 CASTABLE PRESECTIONED BEVELED BARS NORMAL SIZE	€ 19.00
Ref. 150BPN	• 2 CASTABLE PRESECTIONED BARS NORMAL SIZE	€ 19.00



Ref. 192ACN	CAPS ASSORTMENT KIT OT CAP NORMAL SIZE KIT CONTAINS • 1 STAINLESS STEEL HOUSING • 1 PROCESSING CAP • 1 PROTECTIVE DISK • 4 RETENTIVE CAPS (1 GREEN, 1 YELLOW, 1 PINK, 1 CLEAR)	€ 25.00
--------------------	---	---------



Ref. 048CAN	• 6 SILVER CAPS NORMAL SIZE (EXTRA-RESILIENT) (ELASTIC AND GUMMY) - 350g	€ 26.00
--------------------	--	---------



Ref. 048CON	• 6 GOLD CAPS NORMAL SIZE (EXTRA-RESILIENT) (SLIGHTLY ELASTIC) - 500g	€ 26.00
--------------------	---	---------



Ref. 049PCN	• 6 GREEN CAPS NORMAL SIZE (VERY ELASTIC RETENTION) - 350g	€ 26.00
--------------------	--	---------



Ref. 060CRN AY	• 6 YELLOW CAPS NORMAL SIZE (EXTRA SOFT RETENTION) - 500g	€ 26.00
-----------------------	---	---------



Ref. 040CRN SN	• 6 PINK CAPS NORMAL SIZE (SOFT RETENTION) - 900g	€ 26.00
-----------------------	---	---------



Ref. 040CRN	• 6 CLEAR CAPS NORMAL SIZE (STANDARD RETENTION) - 1300g	€ 26.00
--------------------	---	---------



Ref. 040TCN	• 2 TITAN CAPS NORMAL SIZE	€ 36.00
--------------------	----------------------------	---------



Ref. 043CLN	• 6 BLACK CAPS NORMAL SIZE (FOR LABORATORY USE ONLY)	€ 11.00
--------------------	--	---------



Ref. 049PCNDR8	• 6 ORANGE CAPS NORMAL SIZE (VERY ELASTIC RETENTION) (UNDERSIZED INTERNAL DIAMETER FOR WORN OUT SPHERE OR FOR Ø 2.25 SPHERE) - 350 gr	€ 26.00
-----------------------	---	---------



Ref.060CRNAYDR8	• 6 YELLOW CAPS NORMAL SIZE (EXTRA SOFT RETENTION) (UNDERSIZED INTERNAL DIAMETER FOR WORN OUT SPHERE OR FOR Ø 2.25 SPHERE) - 500 gr	€ 26.00
------------------------	---	---------



Ref.040CRNSNDR8	• 6 PINK CAPS NORMAL SIZE (SOFT RETENTION) (UNDERSIZED INTERNAL DIAMETER FOR WORN OUT SPHERE OR FOR Ø 2.25 SPHERE) - 900 gr	€ 26.00
------------------------	---	---------



Ref. 040CRNDR8	• 6 AQUA CAPS NORMAL SIZE (STRONG RETENTION) (UNDERSIZED INTERNAL DIAMETER FOR WORN OUT SPHERE OR FOR Ø 2.25 SPHERE) - 1300 gr	€ 26.00
-----------------------	--	---------



Ref. 042AMN	• 2 MONO OT BOX NORMAL SIZE (CASTABLE HOUSINGS FOR CAPS)	€ 19.00
--------------------	--	---------



Ref. 041CAN	• 2 STAINLESS STEEL HOUSINGS NORMAL SIZE	€ 18.00
--------------------	--	---------



Ref. 041CTN	• 2 TITANIUM HOUSINGS NORMAL SIZE	€ 27.00
--------------------	-----------------------------------	---------



Ref. 101PPN	• 2 PLASTIC POSITIONERS NORMAL SIZE	€ 5.00
--------------------	-------------------------------------	--------



Ref. 044PPN	• 2 NORMAL SPHERE ANALOGS	€ 22.00
--------------------	---------------------------	---------



Ref. 100SAN	• 10 ALUMINIUM SPACERS FOR OT BOX BARS NORMAL SIZE	€ 7.00
--------------------	--	--------

SPARE PARTS OT CAP SYSTEM MICRO Ø1.8mm



Ref. 055SCM

• 4 CASTABLE SPHERES MICRO SIZE

€ 19.00

Ref. 151BAM

• 2 CASTABLE PRESECTIONED BEVELED BARS MICRO SIZE

€ 19.00

Ref. 150BPM

• 2 CASTABLE PRESECTIONED BARS MICRO SIZE

€ 19.00



Ref. 192ACM

CAPS ASSORTMENT KIT OT CAP MICRO SIZE
KIT CONTAINS

- 1 STAINLESS STEEL HOUSING
- 1 PROCESSING CAP
- 1 PROTECTIVE DISK
- 4 RETENTIVE CAPS (1 GREEN, 1 YELLOW, 1 PINK, 1 CLEAR)

€ 25.00



Ref. 048CAM

• 6 SILVER CAPS MICRO SIZE (EXTRA-RESILIENT)
(ELASTIC AND GUMMY) - 200g

€ 26.00



Ref. 048COM

• 6 GOLD CAPS MICRO SIZE (EXTRA-RESILIENT)
(SLIGHTLY ELASTIC) - 450g

€ 26.00



Ref. 049PCM

• 6 GREEN CAPS MICRO SIZE
(VERY ELASTIC RETENTION) - 200g

€ 26.00



Ref. 060CRM AY

• 6 YELLOW CAPS MICRO SIZE
(EXTRA SOFT RETENTION) - 450g

€ 26.00



Ref. 040CRM SN

• 6 PINK CAPS MICRO SIZE
(SOFT RETENTION) - 800g

€ 26.00



Ref. 040CRM

• 6 CLEAR CAPS MICRO SIZE
(STANDARD RETENTION) - 1100g

€ 26.00



Ref. 040TCM

• 2 TITAN CAPS MICRO SIZE

€ 36.00



Ref. 043CLM

• 6 BLACK CAPS MICRO SIZE (FOR LABORATORY USE ONLY)

€ 11.00



Ref. 040CRMDR8

• 6 AQUA CAPS MICRO SIZE (STRONG RETENTION)
(UNDERSIZED INTERNAL DIAMETER FOR WORN OUT SPHERE OR FOR Ø1,6 mm) - 1100g

€ 26.00



Ref. 049PCMDR8

• 6 ORANGE CAPS MICRO SIZE (VERY ELASTIC RETENTION)
(UNDERSIZED INTERNAL DIAMETER FOR WORN OUT SPHERE OR FOR Ø1,6 mm) - 200g

€ 26.00



Ref. 042AMM

• 2 MONO OT BOX MICRO SIZE
(CASTABLE HOUSINGS FOR CAPS)

€ 19.00



Ref. 041CAM

• 2 STAINLESS STEEL HOUSINGS MICRO SIZE

€ 18.00



Ref. 041CTM

• 2 TITANIUM HOUSINGS MICRO SIZE

€ 27.00



Ref. 101PPM

• 2 PLASTIC POSITIONERS MICRO SIZE

€ 5.00



Ref. 044PPM

• 2 MICRO SPHERE ANALOGS

€ 22.00



Ref. 100SAM

• 10 ALUMINIUM SPACERS FOR OT BOX BARS MICRO SIZE

€ 7.00

NORMAL-MICRO TOOLS



Ref. 485IC

• EXTRACTOR/INSERTER TOOL FOR CAPS - NORMAL AND MICRO SIZES
(FOR THE INSERTION OF THE CAPS INSIDE THE METAL HOUSINGS)

€ 39.00



Ref. 74AC01

• KEY FOR PARALLELOMETER NORMAL SIZE

€ 22.00



Ref. 74AC02

• KEY FOR PARALLELOMETER MICRO SIZE

€ 22.00



Ref. 74AC03

• TECNO KEY FOR PARALLELOMETER NORMAL AND MICRO SIZES
(ONLY FOR OT CAP TECNO)

€ 22.00







Ref. 491EC

• MULTIUSE REMOVAL TOOL FOR RETENTIVE CAPS

€ 29.00

NORMAL-MICRO TOOLS continue

	Ref. 080RCN	• REAMER TOOL FOR OT CAPS - NORMAL SIZE	€ 22.00
	Ref. 080RCM	• REAMER TOOL FOR OT CAPS - MICRO SIZE	€ 22.00
	Ref. 082ATN	• TOOL FOR TESTING CAP RETENTION - NORMAL SIZE	€ 22.00
	Ref. 083ATM	• TOOL FOR TESTING CAP RETENTION - MICRO SIZE	€ 22.00

NORMAL - MICRO ACCESSORIES AND Ø2.2mm

	Ref. 155CC	• 6 CONNECTORS	€ 18.00
	Ref. 187CRS	• 2 CONCAVE SPHERES AVAILABLE: Ø1.8 - 2.2 - 2.5mm	€ 84.00
	Ref. 187CRE	• 2 CONCAVE OT EQUATOR	€ 84.00
	Ref. 189SRS	• 2 SOLID SPHERES AVAILABLE: Ø1.8mm	€ 80.00
	Ref. 100PD	• 10 PROTECTIVE DISKS (internal diameter 1,6mm)	€ 10.00
	Ref. 100PDR	• 10 PINK PROTECTIVE DISKS (internal diameter 2,9mm)	€ 10.00
	Ref. 038GCS	• 2 CASTABLE SLIDING BASES	€ 10.00
	Ref. 044PP22	• 2 MICRO ANALOGS Ø2.2mm	€ 22.00

OT CAP ASSORTMENT KIT

KIT NORMAL

Ref. 074KAN

KIT MICRO

Ref. 074KAM

KIT CONTAINS

- 8 CLEAR CAPS - STANDARD RETENTION
- 8 PINK CAPS - SOFT RETENTION
- 6 YELLOW CAPS - EXTRA SOFT RETENTION
- 6 GREEN CAPS - VERY ELASTIC RETENTION
- 6 GOLD CAPS - (EXTRA RESILIENT) SLIGHTLY ELASTIC
- 6 SILVER CAPS - (EXTRA RESILIENT) ELASTIC AND GUMMY
- 4 LIGHT GREEN CAPS - STANDARD (FOR WORN OUT SPHERE)
- 4 ORANGE CAPS - ELASTIC (FOR WORN OUT SPHERE)
- 4 BLACK CAPS - LABORATORY USE ONLY
- 2 TITAN CAPS

€ 192.00

ASSORTMENT KIT NORMAL & MICRO

KIT CONTAINS

- 4+4 CLEAR CAPS - STANDARD RETENTION
- 4+4 PINK CAPS - SOFT RETENTION
- 2+2 YELLOW CAPS - EXTRA SOFT RETENTION
- 3+3 GREEN CAPS - VERY ELASTIC RETENTION
- 3+3 GOLD CAPS - (EXTRA RESILIENT) SLIGHTLY ELASTIC
- 3+3 SILVER CAPS - (EXTRA RESILIENT) ELASTIC AND GUMMY
- 2+2 LIGHT GREEN CAPS - STANDARD (FOR WORN OUT SPHERE)
- 2+2 ORANGE CAPS - ELASTIC (FOR WORN OUT SPHERE)
- 2+2 BLACK CAPS - LABORATORY USE ONLY
- 1+1 TITAN CAPS

€ 192.00

OT CAP ASSORTED RETENTIVE CAPS

NORMAL KIT

- 6 GREEN CAPS - VERY ELASTIC RETENTION
- 6 YELLOW CAPS - EXTRA SOFT RETENTION
- 6 PINK CAPS - SOFT RETENTION
- 6 CLEAR CAPS - STANDARD RETENTION

€ 95.00





OT CAP ASSORTED RETENTIVE CAPS

MICRO KIT

- 6 GREEN CAPS - VERY ELASTIC RETENTION
- 6 YELLOW CAPS - EXTRA SOFT RETENTION
- 6 PINK CAPS - SOFT RETENTION
- 6 CLEAR CAPS - STANDARD RETENTION

€ 95.00





OT STRATEGY SPARE PARTS

	Ref. 154PCS	• 4 OT STRATEGY STANDARD MALES	€ 19.00
	Ref. 054PLS	• 4 OT STRATEGY HIGH MALES	€ 19.00
	Ref. 154STY	• 2 CASTABLE STEADY	€ 9.00
	Ref. 047CSD AY	• 4 STRATEGY YELLOW CAPS FOR DUPLICATION TECHNIQUE (EXTRA SOFT RETENTION) - 500gr	€ 26.00
	Ref. 047CSD SN	• 4 STRATEGY PINK CAPS FOR DUPLICATION TECHNIQUE (SOFT RETENTION) - 900gr	€ 26.00
	Ref. 047CSD	• 4 STRATEGY CLEAR CAPS FOR DUPLICATION TECHNIQUE (STANDARD RETENTION) - 1300gr	€ 26.00
	Ref. 047CLS	• 4 STRATEGY BLACK CAPS FOR DUPLICATION TECHNIQUE (FOR LABORATORY USE ONLY)	€ 11.00
	Ref. 047CSDDR8	• 4 AQUA STRATEGY CAPS FOR DUPLICATION TECHNIQUE (UNDERSIZED INTERNAL DIAMETER FOR WORN SPHERE OR 1.7mm SPHERE)	€ 26.00
	Ref. 045CSM AY	• 4 STRATEGY YELLOW CAPS FOR S/STEEL HOUSING (EXTRA SOFT RETENTION) - 500gr (TO BE USED ONLY WITH HOUSINGS)	€ 21.00
	Ref. 045CSM SN	• 4 STRATEGY PINK CAPS FOR S/STEEL HOUSING (SOFT RETENTION) - 900gr (TO BE USED ONLY WITH HOUSINGS)	€ 21.00
	Ref. 045CSM	• 4 STRATEGY CLEAR CAPS FOR S/STEEL HOUSING (STANDARD RETENTION) - 1300gr (TO BE USED ONLY WITH HOUSINGS)	€ 21.00
	Ref. 045CLS	• 4 STRATEGY BLACK CAPS FOR S/STEEL HOUSING (FOR LABORATORY USE ONLY)	€ 11.00
	Ref. 045CSMDR8	• 4 AQUA STRATEGY CAPS FOR S/STEEL HOUSING (UNDERSIZED INTERNAL DIAMETER FOR WORN SPHERE OR 1.7mm SPHERE)	€ 21.00
	Ref. 046CSM	• 2 STRATEGY STAINLESS STEEL HOUSINGS	€ 20.00
	Ref. 101OTS	• 2 STRATEGY PLASTIC POSITIONERS (FOR SOLDERING STAINLESS STEEL HOUSINGS)	€ 5.00
OT STRATEGY ASSORTMENT CAP KIT FOR DUPLICATION TECHNIQUE			
	Ref. 047ACS	KIT CONTAINS • 4 YELLOW CAPS - EXTRA SOFT RETENTION • 4 PINK CAPS - SOFT RETENTION • 4 CLEAR CAPS - STANDARD RETENTION	€ 68.00
OT STRATEGY ASSORTMENT CAP KIT FOR S/STEEL HOUSINGS			
	Ref. 045ACS	KIT CONTAINS • 4 YELLOW CAPS - EXTRA SOFT RETENTION • 4 PINK CAPS - SOFT RETENTION • 4 CLEAR CAPS - STANDARD RETENTION	€ 55.00
	Ref. 044PPS	• 2 STRATEGY ANALOGS	€ 32.00
	Ref. 486ICS	• INSERTOR/EXTRACTOR TOOL FOR STRATEGY CAPS	€ 39.00
	Ref. 75AC04	• PARALLELOMETER KEY FOR STRATEGY CAPS	€ 22.00
	Ref. 081RCS	• REAMER TOOL FOR STRATEGY CAPS	€ 22.00





OT BAR MULTIUSE SPARE PARTS







	Ref. 022OBB	• 2 CASTABLE BARS OT BAR MULTIUSE	€ 16,00
	Ref. 025CPB	• 4 CASTABLE BOXES OT BAR MULTIUSE	€ 18,00
	Ref. 023CPA	• 4 POSITIONER CLIPS A	€ 16,00
	Ref. 024CPB	• 4 POSITIONER CLIPS B	€ 16,00
	Ref. 027CRG	• 4 YELLOW CLIPS (MEDIUM RETENTION 1,8Kg)	€ 18,00
	Ref. 026CRR	• 4 PINK CLIPS (SOFT RETENTION 1,2Kg)	€ 18,00
	Ref. 027CRS	• 4 RED CLIPS (EXTRA SOFT RETENTION 0,6Kg)	€ 18,00
	Ref. 022RGO	• 2 CASTABLE CONNECTORS	€ 8,00
	Ref. 429IOBM	• INSERTER/EXTRACTOR TOOL FOR OT BAR MULTIUSE CLIPS	€ 39,00
	Ref. 028OCP	• PARALLELOMETER KEY FOR OT BAR MULTIUSE	€ 22,00

OT VERTICAL SPARE PARTS







	Ref. 072MCV	• 2 CASTABLE MALES • 2 PIN KEYS	€ 22,00
	Ref. 072SCV	• 2 CASTABLE STEADY	€ 7,00
	Ref. 072CBV	• 4 WHITE CLIPS (STANDARD RETENTION)	€ 20,00
	Ref. 072CVV	• 4 GREEN CLIPS (SOFT RETENTION)	€ 20,00
	Ref. 472ICV	• 1 INSERTION TOOL FOR OT VERTICAL CLIPS	€ 39,00

OT REVERSE 3 SPARE PARTS



	Ref. 120MR2	• 2 RETENTIVE MALES in TITANIUM + NYLON (Color Clear/ STANDARD RETENTION)	€ 40,00
	Ref. 041CAM	• 2 S/STEEL HOUSINGS MICRO SIZE	€ 18,00
	Ref. 121AOR	• 2 BRASS ANALOGS FOR ROOTS	€ 40,00
	Ref. 121AAR	• 2 INOX IMPLANT ANALOGS	€ 50,00
	Ref. 121MT	• 2 PLASTIC TRANSFERS FOR IMPRESSION	€ 8,00

	Ref. 121AM	• 2 PLASTIC MANUAL TOOLS	€ 8.00
	Ref. 100PDR	• 10 PINK PROTECTIVE DISKS	€ 7.00
	Ref. 121PR	• 2 PLASTIC POSITIONERS FOR DUPLICATION	€ 8.00
	Ref. 124IMR	• METAL INSERTING TOOL FOR OT REVERSE/3 MALE	€ 15.00
	Ref. 72CBR	• S/STEEL PARALLELOMETER KEY FOR CASTABLE BAR	€ 30.00
	Ref. 72CFR	• BRASS PARALLELOMETER KEY FOR TITANIUM FEMALE	€ 30.00

OT LOCK SPARE PARTS

	Ref. 882CS	• 1 SLIDING KEY <i>(ONLY FOR TITANIUM - CASTABLE LOCKING PIN)</i>	€ 14.00
	Ref. 882AF	• 1 FLEXIBLE RING	€ 18.00
	Ref. 882CB	• 1 LOCKING KEY	€ 20.00
	Ref. 882CPT	• 1 TITANIUM PREFABRICATED HOUSING <i>(ONLY FOR TITANIUM - TITANIUM ADJUSTABLE LOCKING PIN)</i>	€ 19.00
	Ref. 882PPC	• 1 CERAMIC PIN	€ 6.00
	Ref. 882CLSCT	• 1 ADJUSTABLE SLIDING KEY <i>(ONLY FOR TITANIUM ADJUSTABLE LOCKING PIN)</i>	€ 14.00
	Ref. 882DCC	• 9 CASTABLE SPACER RINGS <i>(ONLY FOR TITANIUM ADJUSTABLE LOCKING PIN)</i>	€ 16.00

SPHERE REPAIR KITS

	AVAILABLE Ø 1.8 - 2.2 - 2.5	Ref. 087CRS	CONCAVE REPAIR SPHERE KIT CONTAINS <ul style="list-style-type: none"> • 2 CONCAVE SPHERES IN TITANIUM - TiN COATED • 2 PINK CAPS SOFT RETENTION • 1 INSERTING TOOL • 1 GAUGE AND STRIP HOLDER 	€ 100.00
		Ref. 087CRE	CONCAVE REPAIR OT EQUATOR KIT CONTAINS <ul style="list-style-type: none"> • 2 CONCAVE OT EQUATOR IN TITANIUM - TiN COATED • 2 PINK CAPS SOFT RETENTION • 1 INSERTING TOOL • 1 GAUGE AND STRIP HOLDER 	€ 100.00
		Ref. 089SRS	SOLID REPAIR SPHERE KIT CONTAINS <ul style="list-style-type: none"> • 2 SOLID SPHERES 1.8mm IN TITANIUM - TiN COATED • 2 PINK CAPS SOFT RETENTION • 2 PROTECTIVE DISKS • 1 KEY 	€ 100.00

TITANIUM ATTACHMENTS FOR OVERDENTURE OT REVERSE SYSTEM - OT KLASS:

OT REVERSE SPARE PARTS AND OT KLASS ARE IN STOCK
FOR DETAILED INFORMATION PLEASE E-MAIL US OR CALL OUR OFFICES

ADJUSTABLE DENTURE BOXES

IT IS POSSIBLE TO SET UP SIX DIFFERENT INTERIOR SIZES



Ref. 0P6

KIT CONTAINS

- 6 ASSORTED BOXES
COLOURS:
BLUE - LIGHT BLUE - WHITE

€ 5.00



Ref. 100AS

- 30 SILICONE RINGS

€ 8.00

SMALL PARALLELOMETER

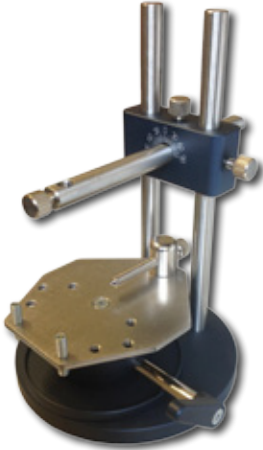

Ref. 00PB

- SMALL PARALLELOMETER DEVICE
WITH MODEL HOLDER BASE
(FOR COURSES, ETC.)

€ 185.00

OT CEM



Ref. OC

KIT CONTAINS

- 1 TWO-COMPONENT SYRINGE 5ml
- 10 AUTOMIX TIPS

€ 44.00

BROKEN SCREW EXTRACTOR KIT

BROKEN SCREW EXTRACTOR KITS ARE MANUFACTURED FOR MOST IMPLANT BRANDS



Ref. 680

KIT CONTAINS

- 1 CLAW REAMER BUR
- 1 REVERSE CUTTING BUR
- 1 MANUAL EXTRACTOR
- 1 CENTERING DEVICE

€ 280,00

Ref. 680FS

- 1 REVERSE CUTTING BUR

€ 50,00

Ref. 680FA*

- 1 CLAW REAMER BUR

€ 50,00

*Specify type of implant and diameter

RHEIN83 RHEIN83 DIRECT SERVICES

A telephone service is available during office hours,
it furnishes direct answers for technical questions.
You can address to Rhein83 for knowing the address of foreign distributors

Tel. 051 244510 - 051 244396 - Fax 051 245238

Rhein83 website
www.rhein83.com

General informations
info@rhein83.com

Sales department
angela.internationaltrade@rhein83.it

Technical support
gianni.storni@rhein83.it

Marketing department
marketing@rhein83.it





Via ZAGO, 10/ABC
40128 - BOLOGNA

Tel. (+39) 051 244510 - (+39) 051 244396
Fax (+39) 051 245238

<http://www.rhein83.com>
e-mail: info@rhein83.com

Distributor



UNI EN ISO 9001:2008
UNI CEI EN ISO 13485:2012